

Hangzhou Hikrobot Technology Co.,Ltd.

SC2000A Series AGV Navigation Sensor

User Manual

HIKROBOT

Legal Information

© Hangzhou Hikrobot Co., Ltd. All rights reserved.

About this Document

This Document includes instructions for using and managing the Product. Pictures, charts, images and all other information hereinafter are for description and explanation only. The information contained in the Document is subject to change, without notice, due to firmware updates or other reasons. Please find the latest version in the company website (<https://en.hikrobotics.com/>). Unless otherwise agreed, Hangzhou Hikrobot Co., Ltd. or its affiliates (hereinafter referred to as "Hikrobot") makes no warranties, express or implied. Please use the Document with the guidance and assistance of professionals trained in supporting the Product.

Acknowledgment of Intellectual Property Rights

- Hikrobot owns the copyrights and/or patents related to the technology embodied in the Products described in this Document, which may include licenses obtained from third parties. Any part of the Document, including text, pictures, graphics, etc., belongs to Hikrobot. No part of this Document may be excerpted, copied, translated, or modified in whole or in part by any means without written permission.
- **HIKROBOT** and other Hikrobot's trademarks and logos are the properties of Hikrobot in various jurisdictions. Other trademarks and logos mentioned are the properties of their respective owners.

LEGAL DISCLAIMER

TO THE MAXIMUM EXTENT PERMITTED BY APPLICABLE LAW, THIS MANUAL AND THE PRODUCT DESCRIBED, WITH ITS HARDWARE, SOFTWARE AND FIRMWARE, ARE PROVIDED "AS IS" AND "WITH ALL FAULTS AND ERRORS". HIKROBOT MAKES NO WARRANTIES, EXPRESS OR IMPLIED, INCLUDING WITHOUT LIMITATION, MERCHANTABILITY, SATISFACTORY QUALITY, OR FITNESS FOR A PARTICULAR PURPOSE. THE USE OF THE PRODUCT BY YOU IS AT YOUR OWN RISK. IN NO EVENT WILL HIKROBOT BE LIABLE TO YOU FOR ANY SPECIAL, CONSEQUENTIAL, INCIDENTAL, OR INDIRECT DAMAGES, INCLUDING, AMONG OTHERS, DAMAGES FOR LOSS OF BUSINESS PROFITS, BUSINESS INTERRUPTION, OR LOSS OF DATA, CORRUPTION OF SYSTEMS, OR LOSS OF DOCUMENTATION, WHETHER BASED ON BREACH OF CONTRACT, TORT (INCLUDING NEGLIGENCE), PRODUCT LIABILITY, OR OTHERWISE, IN CONNECTION WITH THE USE OF THE PRODUCT, EVEN IF HIKROBOT HAS BEEN ADVISED OF THE POSSIBILITY OF SUCH DAMAGES OR LOSS.

YOU ACKNOWLEDGE THAT THE NATURE OF INTERNET PROVIDES FOR INHERENT SECURITY RISKS, AND HIKROBOT SHALL NOT TAKE ANY RESPONSIBILITIES FOR ABNORMAL OPERATION, PRIVACY LEAKAGE OR OTHER DAMAGES RESULTING FROM CYBER-ATTACK, HACKER ATTACK, VIRUS INFECTION, OR OTHER INTERNET SECURITY RISKS; HOWEVER, HIKROBOT WILL PROVIDE TIMELY TECHNICAL SUPPORT IF REQUIRED.

YOU AGREE TO USE THIS PRODUCT IN COMPLIANCE WITH ALL APPLICABLE LAWS, AND

YOU ARE SOLELY RESPONSIBLE FOR ENSURING THAT YOUR USE CONFORMS TO THE APPLICABLE LAW. ESPECIALLY, YOU ARE RESPONSIBLE, FOR USING THIS PRODUCT IN A MANNER THAT DOES NOT INFRINGE ON THE RIGHTS OF THIRD PARTIES, INCLUDING WITHOUT LIMITATION, RIGHTS OF PUBLICITY, INTELLECTUAL PROPERTY RIGHTS, OR DATA PROTECTION AND OTHER PRIVACY RIGHTS. YOU SHALL NOT USE THIS PRODUCT FOR ANY PROHIBITED END-USES, INCLUDING THE DEVELOPMENT OR PRODUCTION OF WEAPONS OF MASS DESTRUCTION, THE DEVELOPMENT OR PRODUCTION OF CHEMICAL OR BIOLOGICAL WEAPONS, ANY ACTIVITIES IN THE CONTEXT RELATED TO ANY NUCLEAR EXPLOSIVE OR UNSAFE NUCLEAR FUEL-CYCLE, OR IN SUPPORT OF HUMAN RIGHTS ABUSES.

THE PERFORMANCE DATA IN THIS PUBLICATION IS BASED ON HIKROBOT'S INTERNAL RESEARCH/EVALUATION. ACTUAL DATA MAY VARY DEPENDING ON SPECIFIC CONFIGURATIONS AND OPERATING CONDITIONS AND HIKROBOT SHALL NOT BEAR THE CONSEQUENCES ARISING THEREFROM.

IN THE EVENT OF ANY CONFLICTS BETWEEN THIS MANUAL AND THE APPLICABLE LAW, THE LATTER PREVAILS.

Regulatory Information

Note

These clauses apply only to the products bearing the corresponding mark or information.

EU Conformity Statement



This product and - if applicable - the supplied accessories too are marked with "CE" and comply therefore with the applicable harmonized European standards listed under the Directive 2014/30/EU(EMCD), Directive 2001/95/EC(GPSD) and Directive 2011/65/EU(RoHS).





2012/19/EU (WEEE directive): Products marked with this symbol cannot be disposed of as unsorted municipal waste in the European Union. For proper recycling, return this product to your local supplier upon the purchase of equivalent new equipment, or dispose of it at designated collection points. For more information see: <http://www.recyclethis.info>



2006/66/EC (battery directive): This product contains a battery that cannot be disposed of as unsorted municipal waste in the European Union. See the product documentation for specific battery information. The battery is marked with this symbol, which may include lettering to indicate cadmium (Cd), lead (Pb), or mercury (Hg). For proper recycling, return the battery to your supplier or to a designated collection point. For more information see: <http://www.recyclethis.info>

Symbol Conventions

The symbols that may be found in this document are defined as follows.

Symbol	Description
 Danger	Indicates a hazard with a high level of risk, which if not avoided, will result in death or serious injury.
 Caution	Indicates a potentially hazardous situation which, if not avoided, could result in equipment damage, data loss, performance degradation, or unexpected results.
 Note	Provides additional information to emphasize or supplement important points of the main text.

Available Model

This manual is applicable to the SC2000A series AGV navigation sensor.

Contact Information

Hangzhou Hikrobot Co., Ltd.

E-mail: global.support@hikrobotics.com

Website: <https://en.hikrobotics.com/>

Contents

Chapter 1 Safety Instruction	1
1.1 Safety Claim	1
1.2 Safety Instruction	1
1.3 Electromagnetic Interference Prevention.....	2
Chapter 2 Overview	4
2.1 Introduction	4
2.2 Key Feature.....	4
Chapter 3 Appearance	5
Chapter 4 12-Pin Connector and Indicator	6
4.1 12-Pin Connector.....	6
4.2 Indicator.....	7
Chapter 5 Installation	8
5.1 Installation Preparation.....	8
5.2 Install Device	8
Chapter 6 Device Connection	9
6.1 Install Client Software	9
6.2 Set PC Network	10
6.3 Set Device Network.....	11
6.4 Connect Device to Client Software.....	11
Chapter 7 Client Software Layout	12
Chapter 8 Functions	14
8.1 Feature Tree.....	14
8.2 Device Control	15
8.3 Image Format Control.....	16
8.4 Acquisition Control	17
8.4.1 Set Frame Rate.....	17
8.4.2 Set Exposure Time	17
8.5 Analog Control.....	18
8.5.1 Set Gain.....	18

8.5.2 Set Brightness	19
8.5.3 Set Gamma Correction	19
8.5.4 Set White Balance	19
8.5.5 Set Color Correction Matrix	21
8.6 Navigation Mode Control	22
8.6.1 Set Navigation Mode	22
8.6.2 Set Calibration Parameters	23
8.7 Code Tape Control	23
8.8 Color Track Control	24
8.9 Algorithm Parameter Control	25
8.10 Light Source Control	26
8.11 Transport Layer Control	27
8.11.1 Communication Protocol	27
8.11.2 Parameters of Transport Layer Control	30
8.12 User Set Customization	31
8.12.1 Save User Set	32
8.12.2 Load User Set	33
8.12.3 Set User Default	33
Chapter 9 FAQ (Frequently Asked Question)	35
9.1 Why the client software cannot list devices?	35
9.2 Why the live view is back?	35
9.3 Why the image is not smooth in live view?	35
9.4 Why codes within the field of view cannot be recognized?	36
Appendix A DM Code Description	37

Chapter 1 Safety Instruction

The safety instructions are intended to ensure that the user can use the device correctly to avoid danger or property loss. Read and follow these safety instructions before installing, operating and maintaining the device.

1.1 Safety Claim

- To ensure personal and device safety, when installing, operating, and maintaining the device, follow the signs on the device and all safety instructions described in the manual.
- The note, caution and danger items in the manual do not represent all the safety instructions that should be observed, but only serve as a supplement to all the safety instructions.
- The device should be used in an environment that meets the design specifications, otherwise it may cause malfunctions, and malfunctions or component damage caused by non-compliance with relevant regulations are not within the scope of the device's quality assurance.
- Our company will not bear any legal responsibility for personal safety accidents and property losses caused by abnormal operation of the device.

1.2 Safety Instruction

Caution

- In the use of the device, you must be in strict compliance with the electrical safety regulations of the nation and region.
- Use the power adapter provided by the official manufacturer. The power adapter must meet the Limited Power Source (LPS) requirements. For specific requirements, please refer to the device's technical specifications.
- It is forbidden to install the indoor device in an environment where it may be exposed to water or other liquids. If the device is damp, it may cause fire and electric shock hazard.
- If the device emits smoke, odor or noise, please turn off the power and unplug the power cord immediately, and contact the dealer or service center in time.
- It is strictly forbidden to wire, maintain, and disassemble the device is powered on. Otherwise, there is a danger of electric shock.
- Protective measures like wearing safety goggles are required when installing, maintaining and debugging the device.
- Avoid aiming the lens at strong light (such as lighting, sunlight, or laser beams, etc.), otherwise the image sensor will be damaged.
- It is forbidden to touch the image sensor directly. If it is necessary to clean, please use wet tissue or soft clean cloth to slightly moisten pure water and gently wipe off dust. It

is forbidden to use alcohol corrosive solution. When cleaning, make sure to power off the device and unplug the power socket. Please keep the image acquisition window clean. It is recommended to wipe with clean water. Damage caused by improper maintenance will not be liable for warranty.

- If the device does not work properly, please contact your dealer or the nearest service center. Never attempt to disassemble the device yourself (we shall not assume any responsibility for problems caused by unauthorized repair or maintenance).
- Please dispose of the device in strict accordance with the relevant national or regional regulations and standards to avoid environmental pollution and property damage.

Note

- Check whether the device's package is in good condition, whether there is damage, intrusion, moisture, deformation, etc. before unpacking.
- Check the surface of the device and accessories for damage, rust, bumps, etc. when unpacking.
- Check whether the quantity and information of the device and accessories are complete after unpacking.
- Store and transport the device according to the storage and transport conditions of the device, and the storage temperature and humidity should meet the requirements.
- It is strictly prohibited to transport the device in combination with items that may affect or damage the device.
- The device should not be placed with exposed flame sources, such as lighted candles.
- Please read the manual and safety instructions carefully before installing the device.
- Quality requirements for installation and maintenance personnel:
 - Qualification certificate or working experience in weak current system installation and maintenance, and relevant working experience and qualifications. Besides, the personnel must possess the following knowledge and operation skills.
 - The basic knowledge and operation skills of low voltage wiring and low voltage electronic circuit connection.
 - The ability to comprehend the contents of this manual.

1.3 Electromagnetic Interference Prevention

- Make sure that the shielding layer of cables is intact and 360° connected to the metal connector when using shielded cables.
- Do not route the device together with other equipment (especially servo motors, high-power devices, etc.), and control the distance between cables to more than 10 cm. Make sure to shield the cables if unavoidable.
- The control cable of the device and the power cable of the industrial light source must be wired separately to avoid bundled wiring.
- The power cable, data cable, signal cable, etc. of the device must be wired separately. Make sure to ground them if the wiring groove is used to separate the wiring and the wiring groove is metal.
- During the wiring process, evaluate the wiring space reasonably, and do not pull the cables hard, so as not to damage the electrical performance of the cables.

- If the device is powered on and off frequently, it is necessary to strengthen the voltage isolation, and consider adding a DC/DC isolation power supply module between the device and the adapter.
- Use the power adapter to supply power to the device separately. If centralized power supply is necessary, make sure to use a DC filter to filter the power supply of the device separately before use.
- The unused cables of the device must be insulated.
- When installing the device, if you cannot ensure that the device itself and all equipment connected to the device are well grounded, you should isolate the device with an insulating bracket.
- To avoid the accumulation of static electricity, ensure that other equipment (such as machines, internal components, etc.) and metal brackets on site are properly grounded.
- Make sure that the connector metal barrier of the device is well connected to the PC and other chassis, and if necessary, copper foil should be used to enhance the grounding effect.
- During the installation and use of the device, high voltage leakage must be avoided.
- Use a figure-eight bundle method if the device cable is too long.
- When connecting the device and metal accessories, they must be connected firmly to maintain good conductivity.
- Use a shielded network cable to connect to the device. If you use a self-made network cable, make sure that the shielding shell at the aviation head is well connected to the aluminum foil or metal braid of the shielding cable.

Chapter 2 Overview

2.1 Introduction

The device is mainly used in AGV positioning and navigation. It acquires images via the AGV navigation sensor, and processes images through its internal algorithms to analyze the QR code in images. The device supports image data acquisition, parameter settings, etc. via the IDMVS client software.

2.2 Key Feature

- Built-in ribbon localization algorithm to effectively localize ribbon.
- Built-in code reading algorithm to read code tapes and array codes.
- Provides good robustness to read codes with spots, defects and low contrast ratio.
- Adopts CMOS sensor to provide high-quality images.
- Adopts multiple indicators for displaying status and debugging.
- Adopts M12 lens and supports large field of view.
- Better optical design to provide uniform illumination and applicable to strong reflection.

Note

- Refer to the device's specifications for specific parameters.
 - The key feature may differ by device models.
 - Refer to **Appendix A DM Code Description** for DM code details.
-

Chapter 3 Appearance

Note

- For specific appearance and dimension, please refer to the device's specification for details.
- The appearance is subject to change, and the actual device you purchased shall prevail.

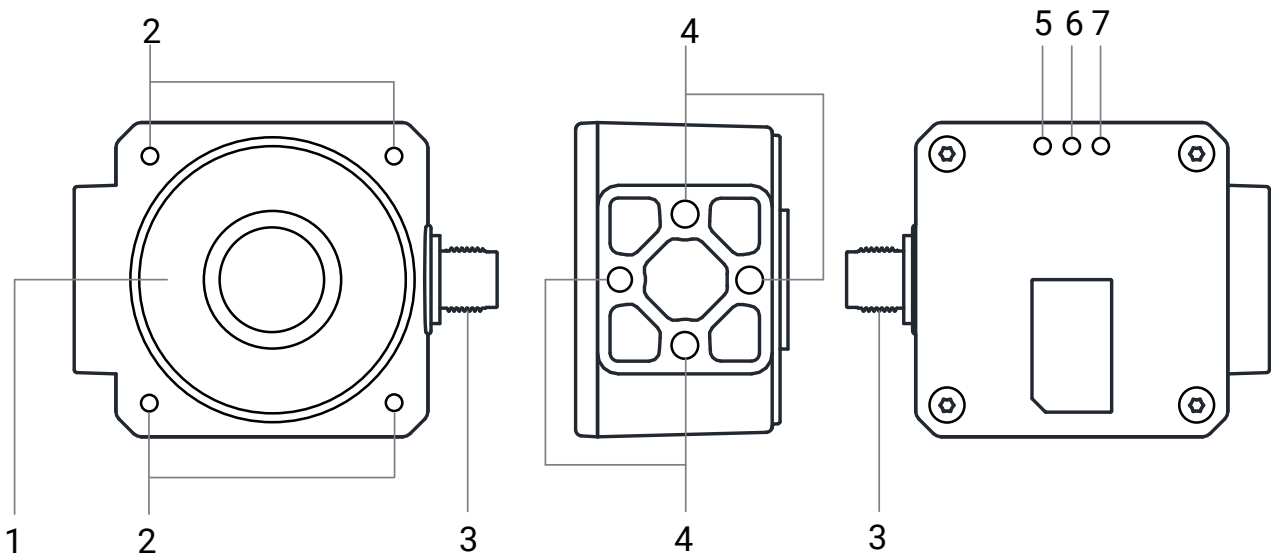

Figure 3-1 Appearance

Table 3-1 Component Description

No.	Component	Description
1	Image Acquisition and Illumination	It is used to acquire images in real time. It also includes a LED light source that provides light.
2	Screw Hole	It is used to fix the device to the installation position, and you can use supplied M4 screws.
3	12-Pin Connector	It provides power supply, Ethernet, and serial port signals.
4	Screw Hole	It is used to fix the device to the installation position. Refer to the device's specification for specific screw information.
5	ETH Indicator	It indicates network transmission status.
6	RUN Indicator	It indicates the device's operation status.
7	PWR Indicator	It indicates the device's power supply status.

Chapter 4 12-Pin Connector and Indicator

4.1 12-Pin Connector

The device has a 12-pin P10 connector that provides power supply, Ethernet, and serial port signals. Refer to the figure and table below for details.

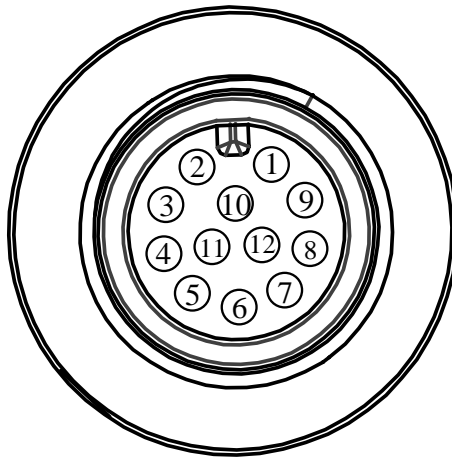

Figure 4-1 12-Pin P10 Connector

Table 4-1 Pin Definitions

No.	Signal	Description	Cable
1	DC-PWR	Direct current power supply positive	White open cable
2	GND	Device's power supply ground	Black open cable
3	Reserved		
4	Reserved		
5	Reserved		
6	Reserved		
7	MDI1+	Fast Ethernet signal MDI1+	RJ45 network connector
8	MDI1-	Fast Ethernet signal MDI1-	RJ45 network connector
9	MDI0+	Fast Ethernet signal MDI0+	RJ45 network connector
10	MDI0-	Fast Ethernet signal MDI0-	RJ45 network connector
11	RS485+	RS485 signal positive	Gray/pink open cable
12	RS485-	RS485 signal negative	Red/blue open cable

The supplied 12-pin cable is shown below. It has a RJ45 network connector that corresponds to 7th, 8th, 9th, and 10th pins of the 12-pin P10 connector.

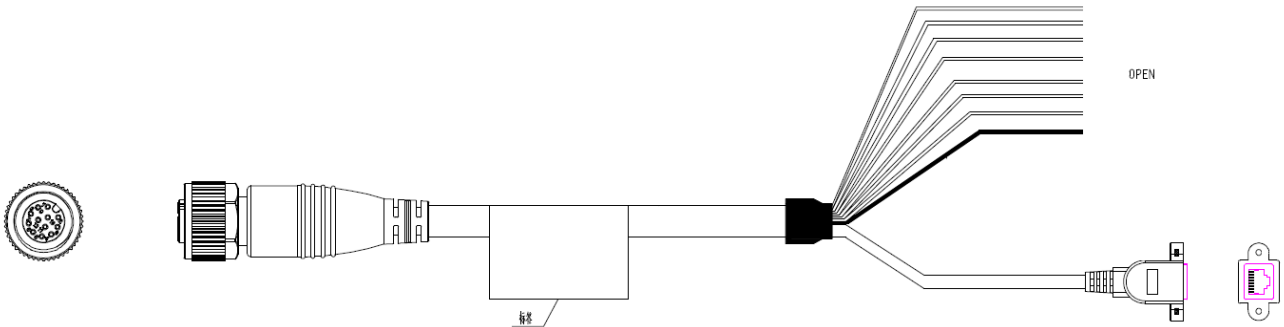

Figure 4-2 12-Pin Cable

Note

You can wire other open cables according to the **Table 4-1**.

4.2 Indicator

The device has three indicators, including PWR indicator, RUN indicator and ETH indicator.

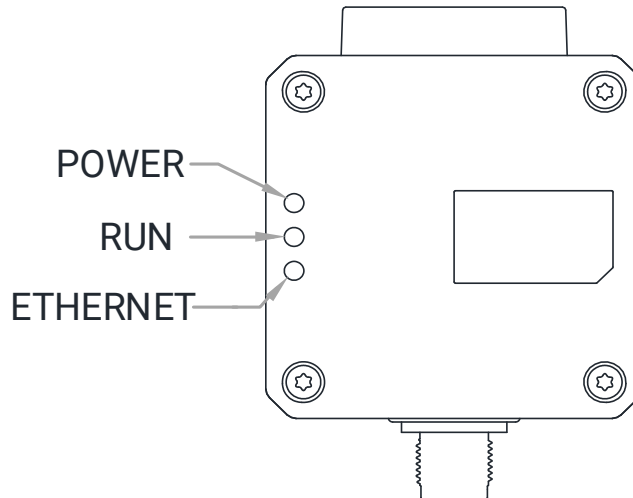

Figure 4-3 Indicators

- PWR indicator: It indicates the device's power supply status. The indicator is solid green if the power supply is normal. Otherwise, it is unlit.
- RUN indicator: It indicates the device's operation status. The indicator is flashing yellow if the device operates normally. When exception occurs, the indicator is solid yellow.
- ETH indicator: It indicates network transmission status. The indicator is flashing yellow if the network is normal. Otherwise, it is unlit.

Chapter 5 Installation

5.1 Installation Preparation

You need to prepare following accessories before device installation.

Table 5-1 Accessories

No.	Name	Quantity	Description
1	12-Pin Cable	1	It refers to the supplied 12-pin cable.
2	DC Power Supply	1	You should select suitable power adapter or switch power supply according to the device power supply and consumption. You need to purchase separately.
3	M4 Screws	Several	It refers to M4 screws used to fix the device.

5.2 Install Device

Before You Start

- Make sure that the device in package is in good condition and all assembly parts are included.
- Make sure that all related devices are powered off during the installation.

Steps

1. Use supplied M4 screws to fix the device to the installation position.
2. Use supplied 12-pin cable to connect the device to a proper power adapter or switch power supply.
3. Use a network cable to connect the device to a switch or a network interface card via 12-pin cable's RJ45 network connector.

Note

The recognizable range of the device is 80 mm to 120 mm, and its working distance during calibration is 100 mm. When the working distance of the device is set to 80 mm or 120 mm:

- The obtained pixel offset will not be affected. After the offset is sent to the AGV, it can help AGV correctly locate the code in the image.
- The obtained physical offset will be affected. After the offset is sent to the AGV, it will affect the driving route of the AGV.

Therefore, it is recommended to keep the working distance within 100 mm ± 5 mm when installing the device.

Chapter 6 Device Connection

Device connection to the client software is required for device's configuration and remote operations. This section introduces how to install the client software, set PC environment, connect the device to the client software, etc.

6.1 Install Client Software

IDMVS is a client software for device configuration and remote operations.

Steps

Note

- Check the Windows version. The client software is compatible with 32/64-bit Windows XP/7/10.
 - It is recommended to install the latest version of the client software, and you can download the installation package from <https://en.hikrobotics.com/>.
 - The graphic user interface may differ by versions of client software you use.
-

1. Double click the installation package to start installing the client software.
2. Select the language.
3. Read and check **Terms of the License Agreement**.
4. Click **Start Setup**.
5. Select installation directory and click **Next**.

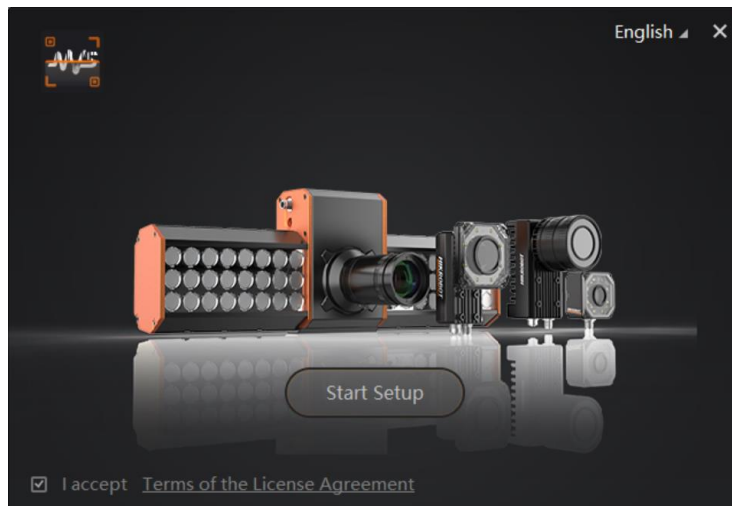

Figure 6-1 Installation Interface

6. Finish the installation according to the interface prompts.

6.2 Set PC Network

To ensure stable client running and data transmission, you are recommended to set PC network.

Steps

Note

For different Windows versions, the specific setting path and interface may differ. Please refer to the actual condition.

1. Go to PC network settings page: **Start** → **Control Panel** → **Network and Internet** → **Network and Sharing Center** → **Change adapter settings**.
2. Select NIC and set the IP obtainment mode.
 - Select **Obtain an IP address automatically** to get an IP address of the PC automatically.
 - Or select **Use the following IP address** to set an IP address for the PC manually.

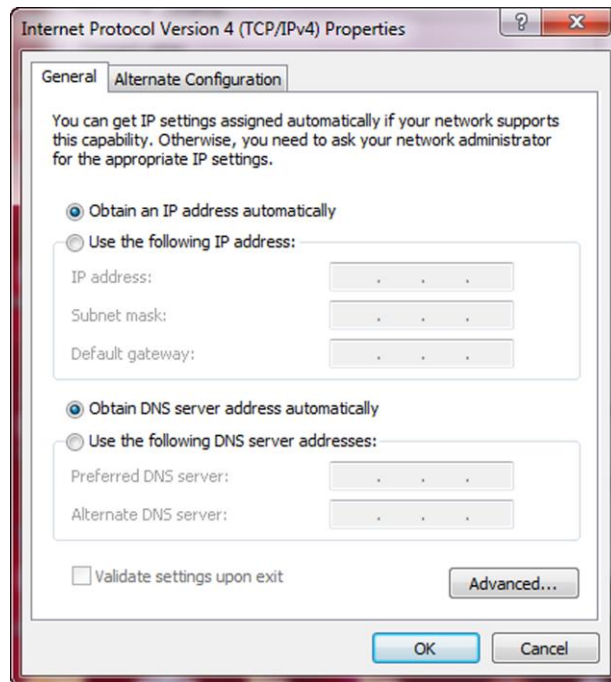



Figure 6-2 Set PC Network

3. Set NIC property.
 - 1) Go to NIC settings page: **Control Panel** → **Hardware and Sound** → **Device Manager** → **Network Adapter**.
 - 2) Select corresponding network interface card, and click **Link Speed**.
 - 3) Set **Speed and Duplex** as **Auto-Negotiation** or **100 Mbps**.

6.3 Set Device Network

You can set and operate the device in the client software only when the device is in the same network segment with the PC where the client software is installed.

Steps

1. Double click the client software to run it.
2. Click  in device list to search the device.
3. Select a device to be connected.
4. Right click the device and click **Modify IP**.
5. Set the IP address of the device in the same network segment with the PC.
6. Click **OK**.

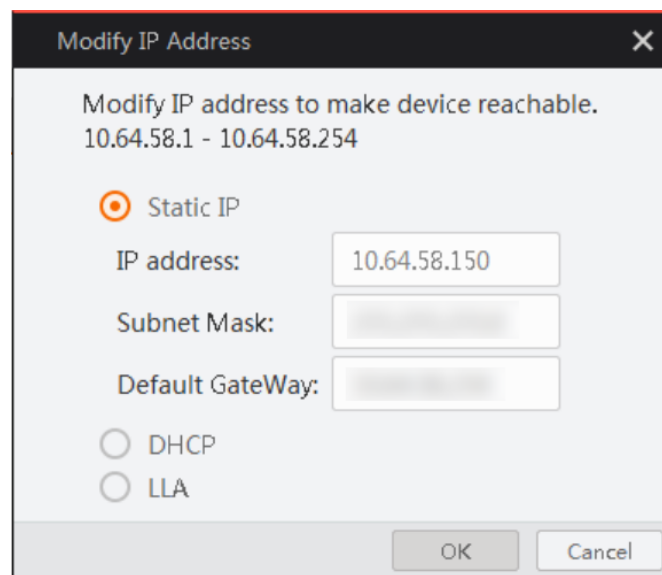



Figure 6-3 Set Device Network

6.4 Connect Device to Client Software

Note

Make sure that your device's IP address is in the same network segment with the PC where you installed the client software before connecting the device to it.

Double click the device name in the device list, or click  to connect the device to the client software.

Chapter 7 Client Software Layout

After connecting to the device, the client software can read the device information and display it.

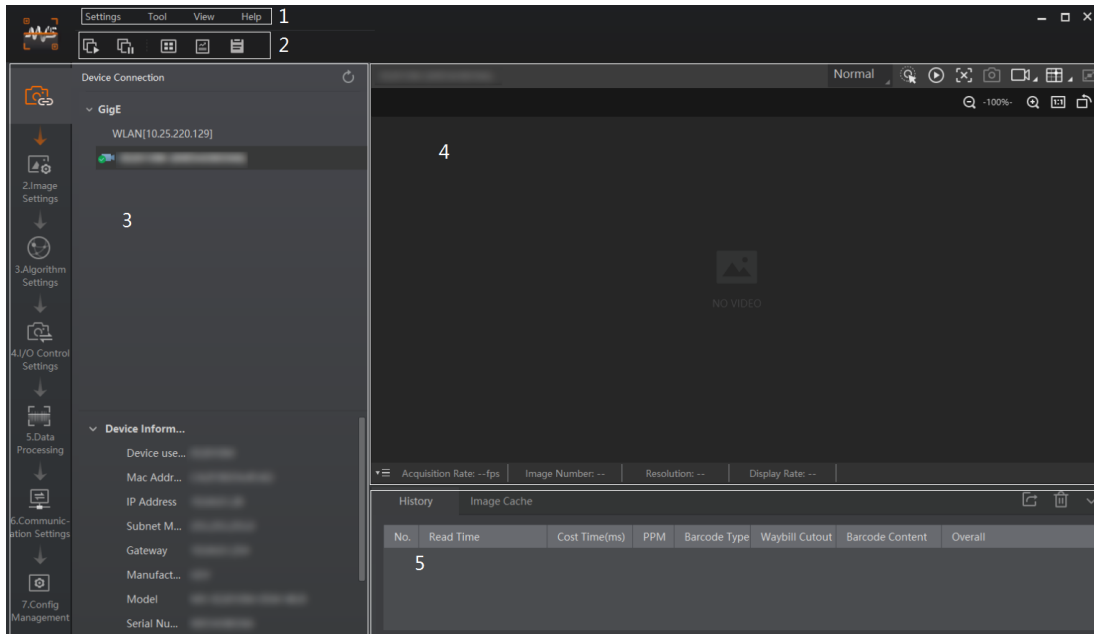

Figure 7-1 Main Window

Note

The specific interfaces of the client software may differ by its versions.

Table 7-1 Description of Main Window

No.	Name	Description
1	Menu Bar	The menu bar displays function modules, including Settings , Tool , View , and Help .
2	Control Toolbar	The control toolbar provides quick operations for the device. You can click different icons to start or stop batch acquisition, change window layout, view statistics information, and device log.
3	Device Configuration	You can connect or disconnect device, set parameters, and modify device IP address in this area.
4	Live View Window	This area displays the acquisition images and algorithm reading result in real-time. You can click different icons to capture and save image, record, etc.

No.	Name	Description
5	History Record and Image Cache	This area displays different barcode information read by the device in real-time. You can also set image cache here.

You can set device parameters in device configuration area.

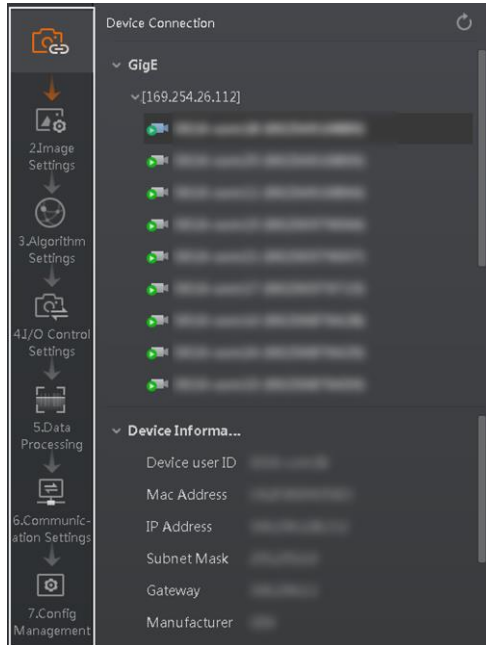

Figure 7-2 Device Configuration Area

Table 7-2 Configuration Area Description

No.	Module Name	Description
1	Device Connection	You can connect or disconnect device, modify device IP address, view device information, etc.
2	Image Settings	You can set image parameters, light parameters, etc.
3	Algorithm Settings	You can add different barcodes, set barcode number, etc.
4	I/O Control Settings	You can set parameters related with input and output.
5	Data Processing	You can set filter rule for output result.
6	Communication Settings	You can select different communication protocols, and set related parameters for output result.
7	Configuration Management	You can save and load user parameters, and restart the device.

Chapter 8 Functions

8.1 Feature Tree

After selecting the device in the device list, right click it and select **Feature Tree**. You can view and set parameters of the device here.

 **Note**

The specific feature tree may differ by device models.

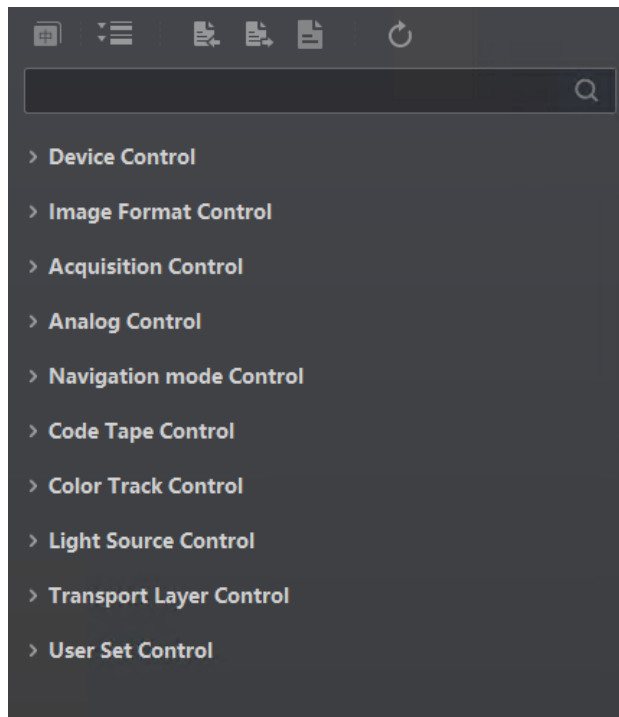

Figure 8-1 Feature Tree

Table 8-1 Feature Tree Description

Feature Name	Description
Device Control	You can view the device information, edit its name, reset the device, etc.
Image Format Control	You can view the image's width and height.
Acquisition Control	You can view the device's frame rate, and set the device's exposure mode and exposure time.
Analog Control	You can view and set the device's gain.

Feature Name	Description
Tdcl Control	You can view and set the device's algorithm parameters.
Navigation Mode Control	You can set AGV's navigation mode.
Code Tape Control	You can set code tape related parameters.
Color Track Control	You can set ribbon related parameters.
Light Source Control	You can enable the light source here and set its duration.
Transport Layer Control	You can set related parameters of transport layer control.
User Set Control	You can save and load the device's user parameters.

8.2 Device Control

Note

The specific device control parameters may differ by device models.

Go to **Device Control**, you can view device information, edit device name, reset device, etc. The specific parameters in **Device Control** are shown below.

The screenshot shows a 'Device Control' panel with the following parameters and values:

- Device Model Name: MV-SC2005AM-02WBN
- Device Version: V2.5.0 211026
- Device Firmware Version: V2.5.0 211026,10101
- Device Serial Number: 00202110134
- Device User ID: SmartCodeReader
- Device Uptime(s): 2138
- Board Device Type: 0x407a
- Device Link Speed(Mbps): 100
- Device Link Heartbeat Mode: On
- Device Reset: Execute

Figure 8-2 Device Control

Table 8-2 Device Control Parameters

Parameter	Read/Write	Description
Device Model Name	Read Only	It is the model of the device.
Device Version	Read Only	It is the version of the device.
Device Firmware Number	Read Only	It is the firmware version of the device.

Parameter	Read/Write	Description
Device Serial Number	Read Only	It is device's serial number.
Device User ID	Read & Write	Device name and it is empty by default. You can set according to your preference. <ul style="list-style-type: none"> • If User ID is empty, the client software displays the device model. • If you set it, the client software displays the User ID you set.
Device Uptime (s)	Read Only	It is the period of time when device is powered up.
Board Device Type	Read Only	It is the device type.
Device Link Speed (Mbps)	Read Only	It indicates the speed of transmission negotiated on the specified link.
Device Link Heartbeat Mode	Read & Write	It activates or deactivates the link's heartbeat.
Device Reset	Read & Write	Click Execute to reset the device.

8.3 Image Format Control

Go to **Image Format Control**, you can view the image's width and height, as shown below.

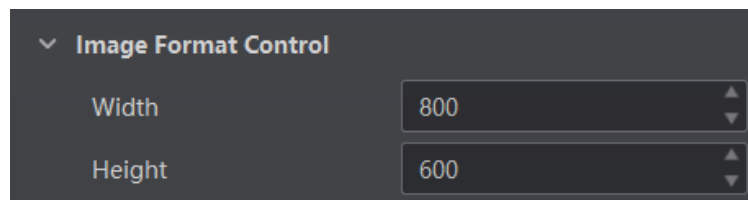

Figure 8-3 Image Format Control

8.4 Acquisition Control

8.4.1 Set Frame Rate

Frame rate refers to the image number that is acquired by the device per second. The higher frame rate, and shorter time used for image acquisition will be.

Go to **Acquisition Control**, you can view the device's real-time frame rate in **Resulting Frame Rate**.

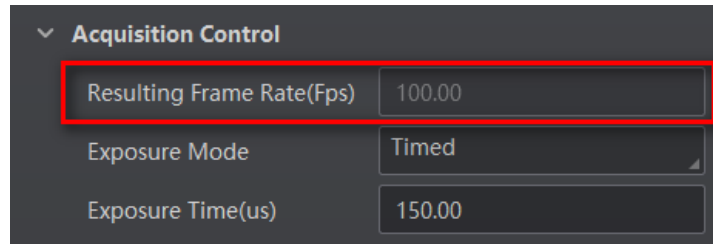

Figure 8-4 Resulting Frame Rate

Note

The device's real time frame rate is related to configured exposure time:

- If the reciprocal of max. frame rate that the device supports is t , and when the configured exposure time is larger than t , the less the exposure time, the higher the frame rate will be.
- If the configured exposure time is less than or equal to t , then the exposure time will not affect the frame rate.

8.4.2 Set Exposure Time

The device supports 3 types of auto exposure mode, including **Off**, **Once** and **Continuous**. Click **Acquisition Control** → **Exposure Auto**, and select the mode according to actual demands.

- **Off**: The device exposures according to the value set in **Exposure Time (μ s)**.
- **Once**: The device adjusts the exposure time automatically according to the image brightness. After adjusting, it will switch to **Off** mode.
- **Continuous**: The device adjusts the exposure time continuously according to the image brightness.

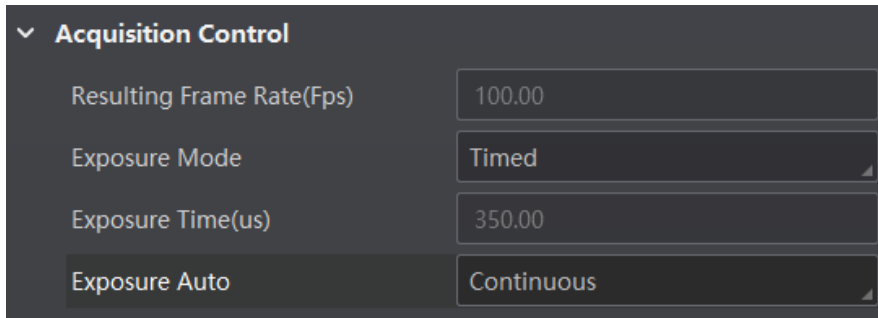

Figure 8-5 Exposure Time

 **Note**

- The exposure time parameter may differ by device models.
 - Increasing exposure time can improve the brightness of the image, but it will reduce the frame rate to a certain extent. It is recommended to set exposure time according to actual demands.
-

8.5 Analog Control

The analog control allows you to set gain, brightness, Gamma correction, white balance, and other parameters.

8.5.1 Set Gain

Go to **Analog Control**, and you can set the device's gain in **Gain(dB)** according to actual demands.

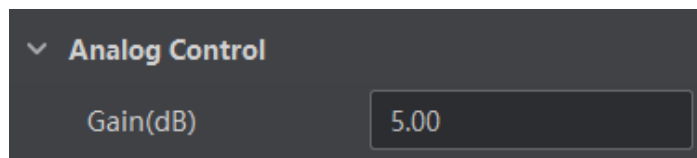

Figure 8-6 Gain

 **Note**

Increasing gain can improve the brightness of the image, but it will also increase noise on the image. It is recommended to set gain according to actual demands.

8.5.2 Set Brightness

Go to **Analog Control**, and you can set the device's brightness according to actual demands. After setting brightness, the device will adjust exposure time automatically to let the image brightness reach the target value.



Figure 8-7 Set Brightness

8.5.3 Set Gamma Correction

Note

The Gamma correction function may differ by device models.

The device supports Gamma correction function. Generally, the output of the device's sensor is linear with the photons that are illuminated on the photosensitive surface of the sensor, and Gamma correction provides a non-linear mapping mechanism. Go to **Analog Control**, and you can set the device's Gamma according to actual demands

- Gamma value between 0.5 and 1: image brightness increases, dark area becomes brighter.
- Gamma value between 1 and 4: image brightness decreases, dark area becomes darker.

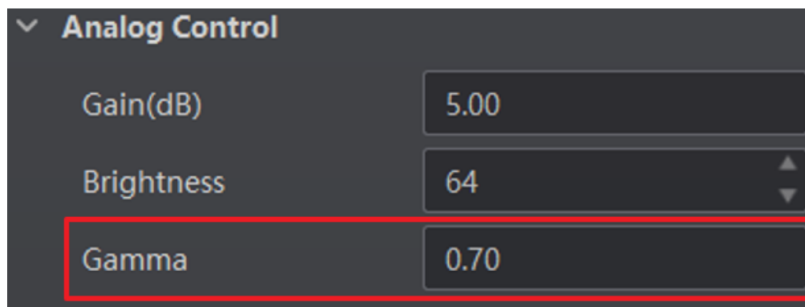

Figure 8-8 Set Gamma Correction

8.5.4 Set White Balance

Note

White balance is only available for color devices.

The white balance refers to the device color adjustment depending on different light sources. Adjust the R/G/B ratio to ensure that the white regions are white under different

color temperatures. Ideally, the proportion of R/G/B in the white region is 1:1:1. It is recommended to correct white balance when there is great difference between the device's color effect and actual effect. You can correct white balance as shown below.

Steps

1. Put a white paper in the range of the device's field of view, and make sure the paper covers the entire field of view.
2. Set exposure and gain.

Note

It is recommended to set image brightness value between 120 and 160.

3. Enable **Awb Enable** in **Analog Control**.
4. Set **Awb Auto** to **Continuous**.

Note

The device will execute white balance automatically.

If there is still great difference between correction effect and actual color, it is recommended to correct white balance according to following steps.

5. Set **Awb Auto** to **Off**, and find 1024 in one of R/G/B channel.
6. Manually adjust other two channels by setting **Awb Param Selector** and **Awb Param Value** to let these three channels have same value.

Note

- In order to avoid repeated correction after rebooting the device, it is recommended to save white balance parameter to **User Set** after white balance correction. You can refer to the Section **Save and Load User Set** for details.
 - If the light source and color temperature in environment change, you need to correct white balance again.
-

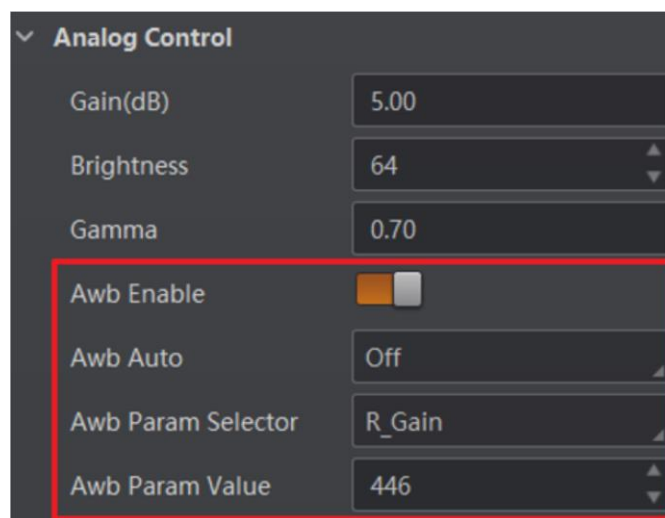

Figure 8-9 Set White Balance

8.5.5 Set Color Correction Matrix

Note

The function of color correction matrix is only available for color devices.

After the image is processed by the white balance, the overall image will be dark, and at the same time, various colors may deviate from their standard values to varying degrees. At this time, it is necessary to multiply the color of the image by the correction matrix to correct each color to its standard value, so that the overall color of the image is more vivid. The color correction function is implemented by multiplying each RGB component by a correction matrix.

Steps

1. Click **Execute** in **CCM Reset**.
 2. Set **CCM Param Selector**.
-

Note

Color correction is achieved by adjusting the values of the parameters in **CCM Param Selector**. The RR_Gain, RG_Gain and RB_Gain adjust the R component of the red pixel, GR_Gain, GG_Gain and GB_Gain adjust the G component of the green pixel, and BR_Gain, BG_Gain and BB_Gain adjust the B component of the blue pixel.

3. Set value in **CCM Param Value**.

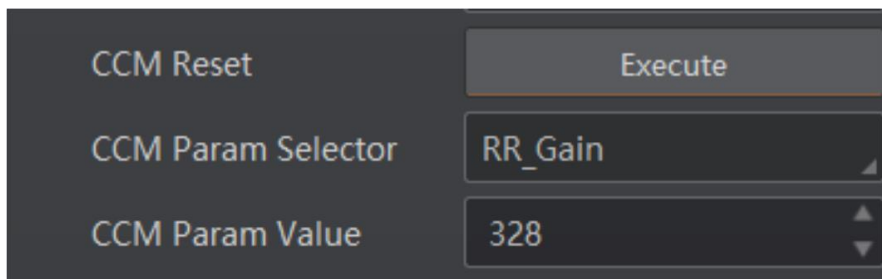

Figure 8-10 Set Color Correction Matrix

8.6 Navigation Mode Control

The navigation mode control sets the AGV's navigation mode, algorithm parameters, and calibration parameters.

8.6.1 Set Navigation Mode

The AGV supports three types of navigation modes, including code guide, color track guide, and array guide.

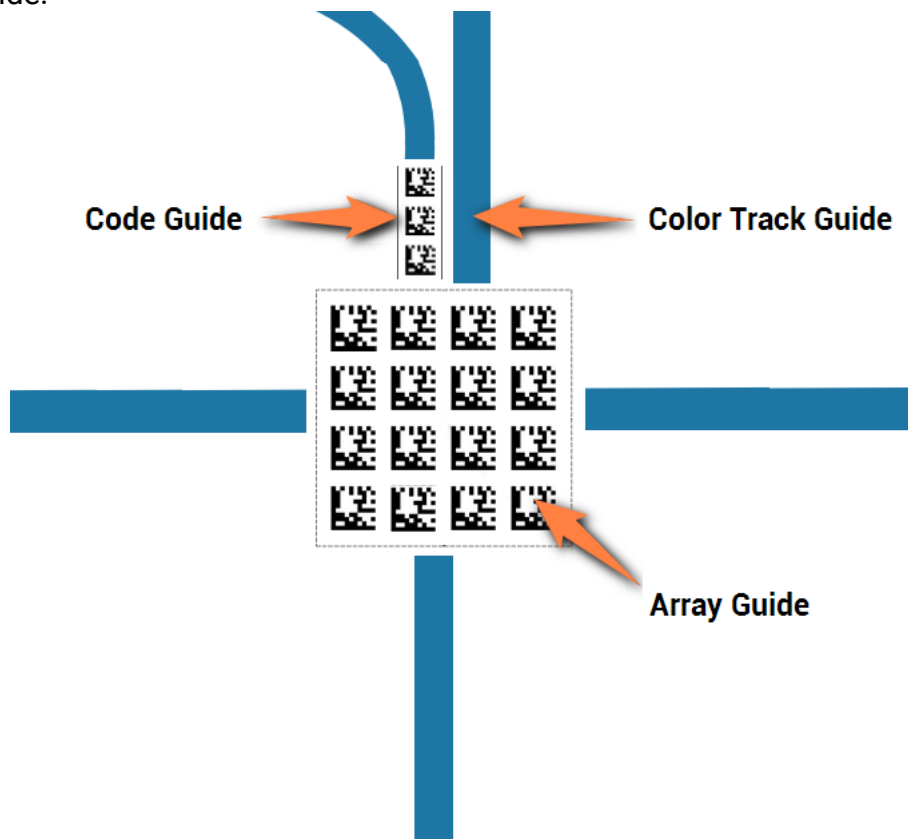

Figure 8-11 Navigation Mode

- Code Guide Enable: After enabling it, the device guides the AGV to operate by recognizing code tape on the ground.
- Color Track Guide Enable: After enabling it, the device guides the AGV to operate by recognizing color track on the ground.
- Array Guide Enable: After enabling it, the device guides the AGV to align the center position of matrix code.
- Trans_enable: After enabling it, the device supports outputting AGV's physical coordinate.
- Undistort Enable: After enabling it, the device supports correcting distortion code.

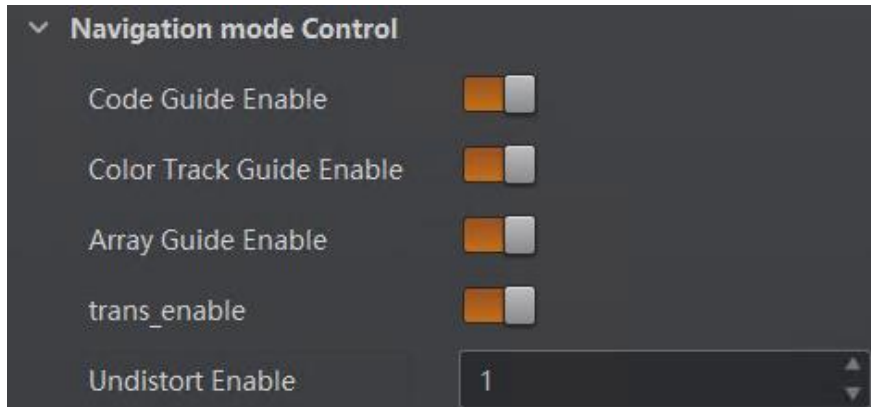

Figure 8-12 Set Navigation Mode

8.6.2 Set Calibration Parameters

The device supports setting calibration data type and viewing calibration state.

- Calibration Type: It selects different calibration position data.
 - CamDown: It is calibration position data by AGV bottom device.
 - CamUpBefore: It is calibration position data by AGV upper device before lifting.
 - CamUpAfter: It is calibration position data by AGV upper device after lifting.
 - Reserve Type: It is a reserved parameter value.
- Calibration State: You can view calibration state.

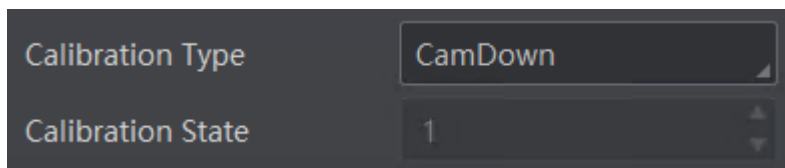

Figure 8-13 Set Calibration Parameters

8.7 Code Tape Control

The code type control is used to set DM code type under code guide or array guide navigation mode.

- Array DM Version: It sets DM code type under array guide navigation mode.
- Control DM Version: It sets DM code type under code guide navigation mode.
- Array Angle Accurate Enable: After it is enabled, the angle information of array guide will be calculated via multi-code fitting method for improving angle position accuracy.
- Control Angle Accurate Enable: After it is enabled, the angle information of code guide will be calculated via multi-code fitting method for improving angle position accuracy.
- Array Position Accurate Enable: After it is enabled, the position information of array guide will be calculated via multi-code fitting method for improving position accuracy.

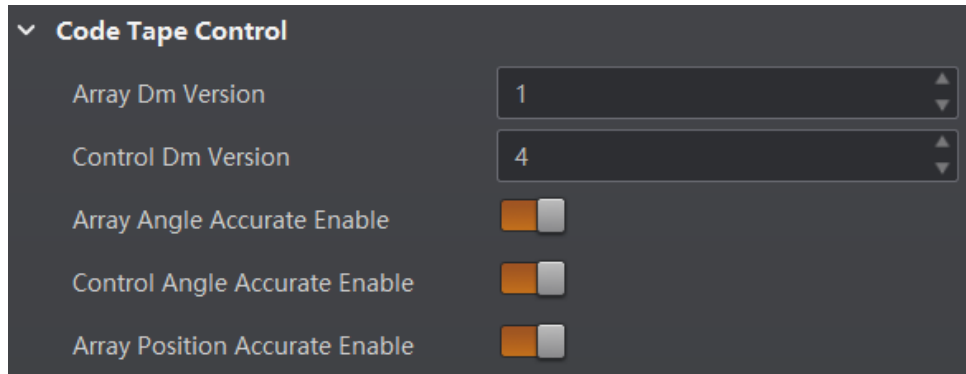

Figure 8-14 Code Tape Control

8.8 Color Track Control

The color track control is used to set parameters under color track guide navigation mode.

Note

Make sure that the **Color Track Guide Enable** is enabled before setting parameters.

- ROI Enable: After it is enabled, you can draw the ROI of color track. The related parameters are shown below.
 - ROIRegion Num: It shows the ROI.
 - ROI Width: It is the width of the ROI.
 - ROI Height: It is the height of the ROI.
 - Offset X: It refers to the x-coordinate of the point in the upper-left corner of the ROI.
 - Offset Y: It refers to the y-coordinate of the point in the upper-left corner of the ROI.
- Ribbon Color Type: It selects ribbon color (RED/BLUE/YELLOW/GREEN).
- Ribbon Line Width: It sets ribbon line width ranging from 0 to 270.
- Red/Blue/Yellow/Green Channel Select: It sets H/S/V channel for different colors.
- Red/Blue/Yellow/Green Channel Threshold Lower: It sets lower threshold for selected channels.
- Red/Blue/Yellow/Green Channel Threshold Upper: It sets upper threshold for selected channels.
- Threshold Increase: Click **Execute** to increase recognition threshold of the color track.
- Threshold Decrease: Click **Execute** to decrease recognition threshold of the color track.

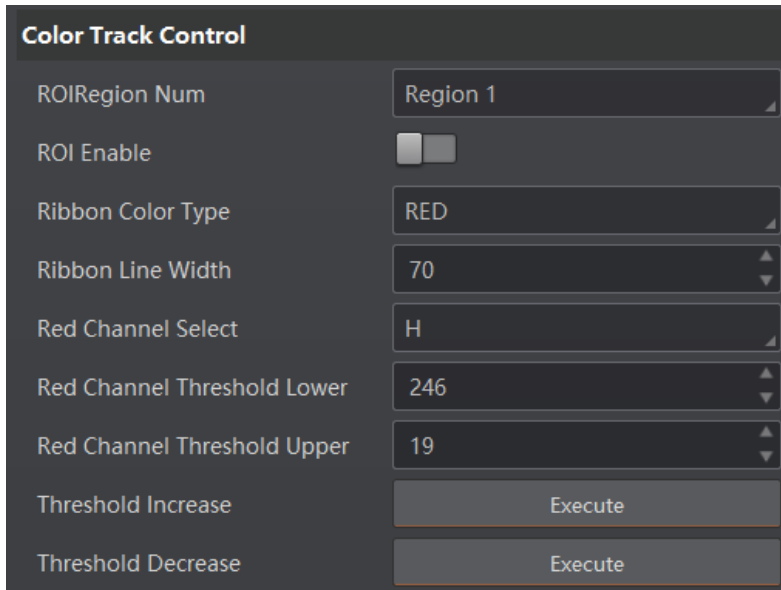

Figure 8-15 Color Track Control

8.9 Algorithm Parameter Control

Go to **Tdcl Control**, you can set the device’s algorithm parameters according to actual demands.

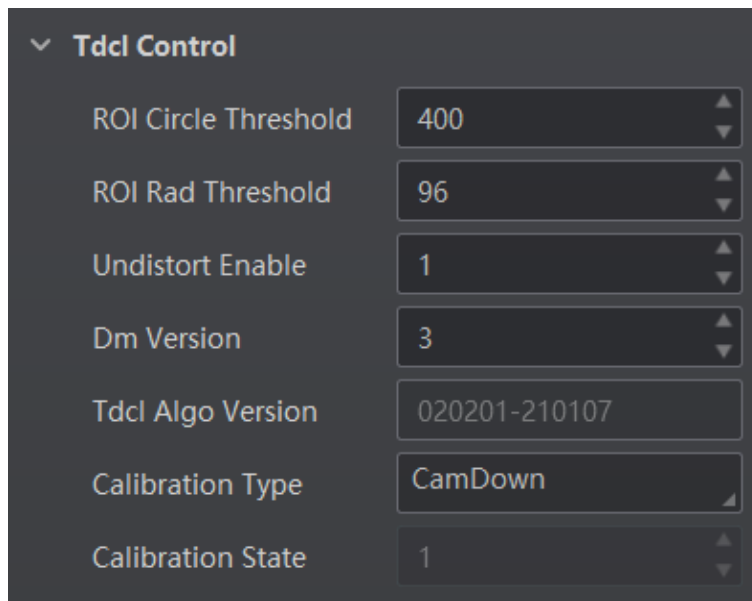

Figure 8-16 Algorithm Parameters

Table 8-3 Algorithm Parameters

Parameter	Description
ROI Circle Threshold	It is the threshold of ROI circle, and its range is 1 to 3000.

Parameter	Description
ROI Rad Threshold	It is the radius of ROI circle, its range is 50 to 200, and unit is pixel.
Undistort Enable	It sets whether the distortion correction function is enabled. <ul style="list-style-type: none"> • When the value is 1, the distortion correction function is enabled, and the code with distortion is corrected and identified. • When the value is 0, the distortion correction function is disabled.
Dm Version	It is the version of Data Matrix with range of 2 to 6.
Tdcl Algo Version	It is algorithm version.
Calibration Type	It includes CamDown, CamUpBefore, CamUpAfter, and ReserveType.
Calibration State	It indicates the calibration type that the device uses currently. It supports CamDown only currently and the value is 1.

8.10 Light Source Control

Go to **Light Source Control**, you can enable **Lighting Enable** to enable light source. If **Lighting Enable** is enabled, you can also set **Lighting Duration** to configure duration.

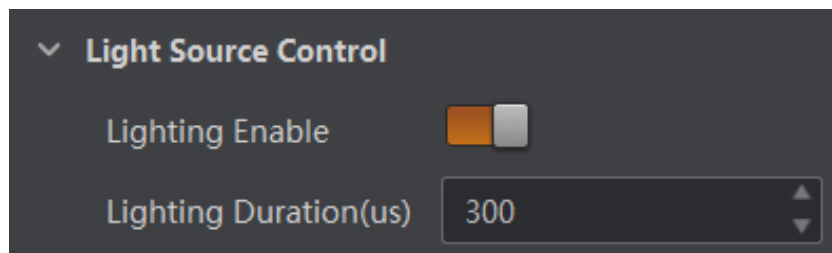

Figure 8-17 Light Source Control

8.11 Transport Layer Control

8.11.1 Communication Protocol

The device supports different communication protocols, and you can set corresponding parameters after selecting specific protocols.

Smart SDK

It is recommended to select Smart SDK if you use SDK to carry out secondary development and receive results.

Steps

1. Go to **Transport Layer Control** → **Result Transfer Protocol**.
2. Select **Smart SDK** as **Result Transfer Protocol**.
3. Enable **Smart SDK**.

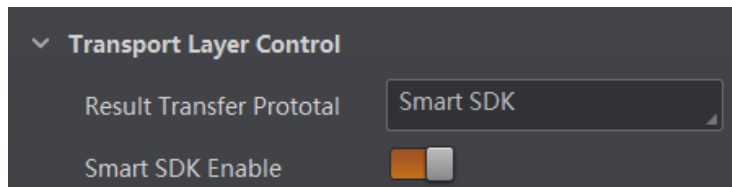

Figure 8-18 Smart SDK

Serial

Steps

1. Go to **Transport Layer Control** → **Result Transfer Protocol**.
2. Select **Serial** as **Result Transfer Protocol**.
3. Enable **Smart Serial Enable**.
4. Set **Serial Baudrate**, **Serial Data Bits**, **Serial Parity**, and **Serial Stop Bits** according to actual demands.

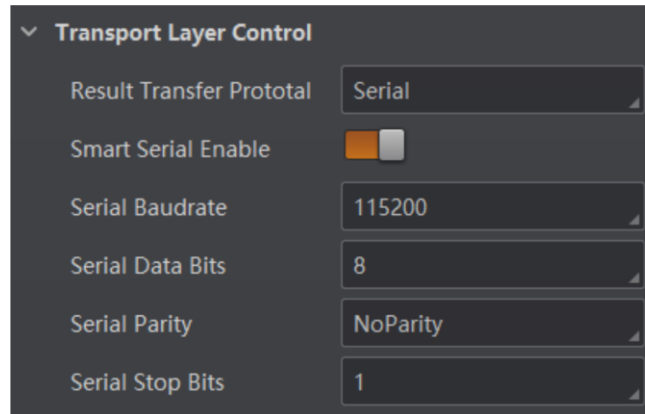

Figure 8-19 Serial

UDP

UDP stands for User Datagram Protocol and is a simple datagram-oriented transport layer protocol.

Steps

1. Go to **Transport Layer Control** → **Result Transfer Protocol**.
2. Select **UDP** as **Result Transfer Protocol**.
3. Enable **Smart UDP Enable**.
4. Set **UDP Dst Addr** and **UDP Dst Port** according to actual demands.

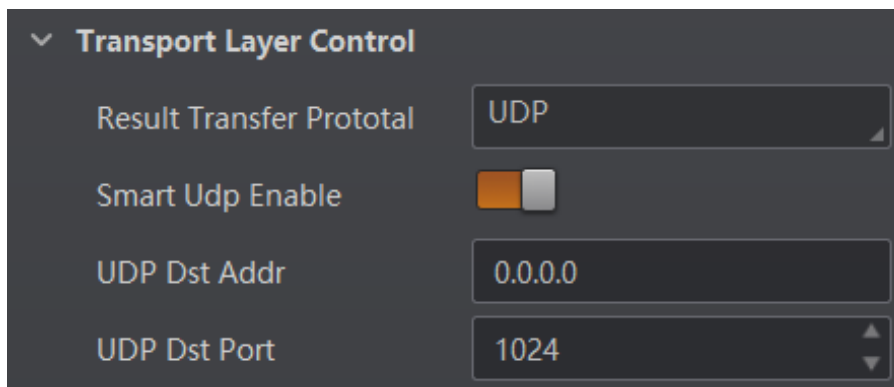

Figure 8-20 UDP

Profinet

Steps

1. Go to **Transport Layer Control** → **Result Transfer Protocol**.
2. Select **Profinet** as **Result Transfer Protocol**.
3. Enable **Profinet Enable**.
4. Enter **Profinet Device Name**, and set **Profinet Result Module Size** and **Profinet Result Timeout** according to actual demands.

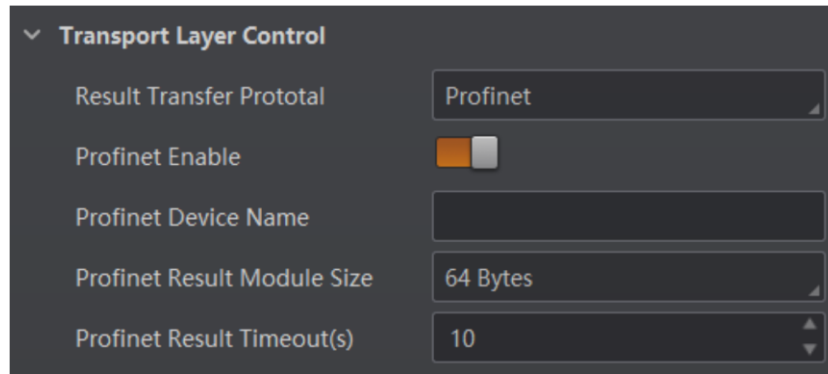

Figure 8-21 Profinet

Modbus

Steps

1. Go to **Transport Layer Control** → **Result Transfer Protocol**.
2. Select **Modbus** as **Result Transfer Protocol**.
3. Enable **Smart Modbus Enable**.
4. Set **Slave ID**, **Modbus Baudrate**, **Modbus Data Bits**, **Modbus Parity**, and **Modbus Stop Bits**.

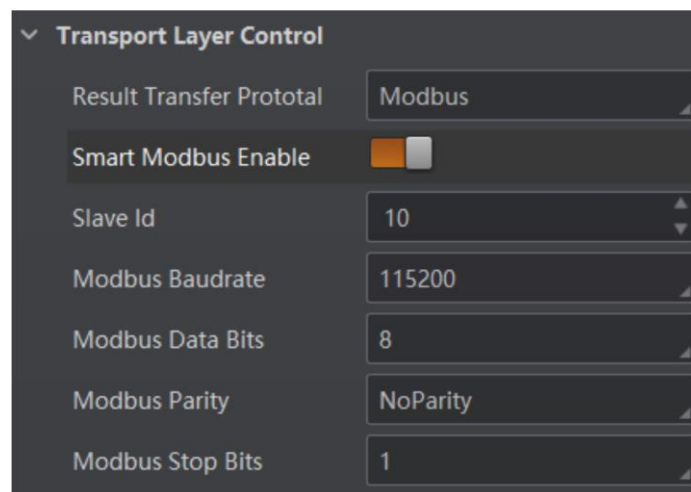

Figure 8-22 Modbus

EthernetIP

Steps

1. Go to **Transport Layer Control** → **Result Transfer Protocol**.
2. Select **EthernetIP** as **Result Transfer Protocol**.
3. Enable **Smart EthernetIP Enable**.

4. Set **EthernetIP Input Assembly Size(Byte)**, **EthernetIp Output Assembly Size(Byte)**, and **EthernetIp Result Timeout(s)**, and enable **EthernetIp Result Byte Swap** according to actual demands.

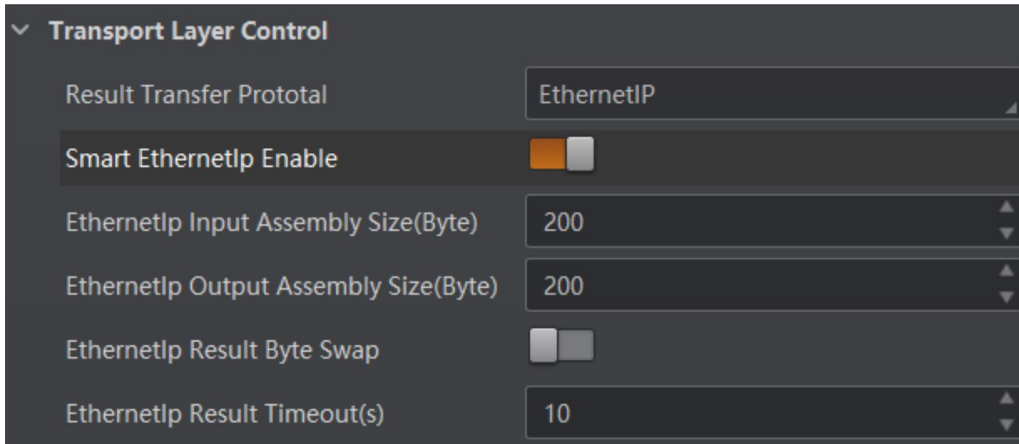

Figure 8-23 EthernetIP

8.11.2 Parameters of Transport Layer Control

You can also go to **Transport Layer Control** to view the device’s related parameters.

Table 8-4 Parameters of Transport Layer Control

Parameter	Read/Write	Description
GEV Current IP Configuration LLA	Read Only	It indicates whether the Link Local Address IP configuration scheme is activated on the given network interface.
GEV Current IP Configuration Persistent IP	Read & Write	It indicates whether persistent IP configuration scheme is activated on the given network interface.
GEV Current IP Address	Read Only	It is the current IP address for the given network interface.
GEV Current Subnet Mask	Read Only	It is the current subnet mask of the given interface.
GEV Current Default Gateway	Read Only	It is the default gateway IP address to be used on the given network interface.
GEV Number of Interfaces	Read Only	It indicates the number of physical network interfaces supported by this device.
GEV Persistent IP Address	Read & Write	It indicates the persistent IP address for this network interface. It is only used when the device boots with the persistent

Parameter	Read/Write	Description
		IP configuration scheme.
GEV Persistent Subnet Mask	Read & Write	It indicates the persistent subnet mask associated with the persistent IP address on this network interface. It is only used when the device boots with the persistent IP configuration scheme.
GEV Persistent Default Gateway	Read & Write	It indicates the persistent default gateway for this network interface. It is only used when the device boots with the persistent IP configuration scheme.
GEV Link Speed	Read Only	It indicates the speed of transmission negotiated by the given network interface in Mbps.
GEV Message Channel Count	Read Only	It indicates the number of message channels supported by this device.
GEV Stream Channel Count	Read Only	It indicates the number of stream channels supported by this device.
GEV Stream Channel Selector	Read Only	It selects the stream channel to control.
GEV SCP Interface Index	Read Only	It is the Index of network interface to be used.
GEV SCP Host Port	Read & Write	It is the host port of the channel
GEV SCP Direction	Read Only	It transmits or receives the channel.
GEV SCPS Packet Size(B)	Read & Write	It specifies the stream packet size (in bytes) to send on this channel.
GEV SCPD	Read & Write	It indicates the delay (in timestamp counter units) to insert between each packet for this stream channel.
GEV SCDA	Read & Write	It indicates the destination IP address for this stream channel.
GEV SCSP	Read Only	It indicates the source UDP port address for this stream channel.

8.12 User Set Customization

This function allows you to save or load device settings. The device supports four sets of parameters, including one default set and three user sets, and the relation among four sets

of parameters is shown below.

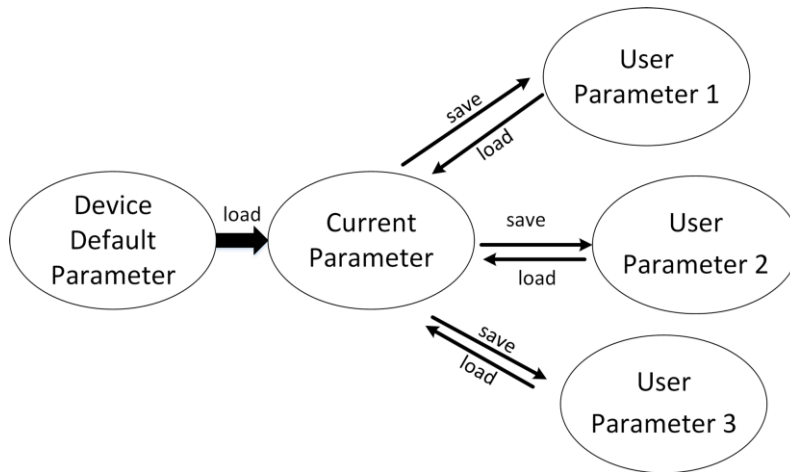

Figure 8-24 Parameter Relation

Note

After setting user parameters, it is recommended to save user parameters and select them as the default parameters.

8.12.1 Save User Set

Steps

1. Go to **User Set Control**, and select a user set in **User Set Selector**.

Note

Here we take selecting **User Set 1** as an example.

2. Click **Execute** in **User Set Save** to save parameter.

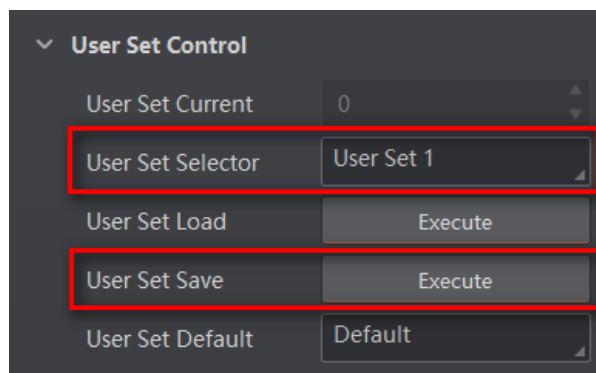

Figure 8-25 Save User Set

8.12.2 Load User Set

Note

Loading user set is available only when the device is connected but without live view.

Steps

1. Go to **User Set Control**, and select a user set in **User Set Selector**.

Note

Here we take selecting **User Set 1** as an example.

2. Click **Execute** in **User Set Load** to load parameter.

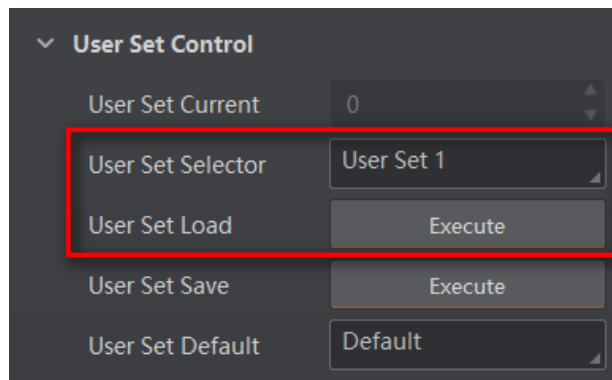

Figure 8-26 Load User Set

8.12.3 Set User Default

You can also set default parameter by going to **User Set Control**, and select a user set in **User Set Default**.

Note

Here we take selecting **User Set 1** as an example.

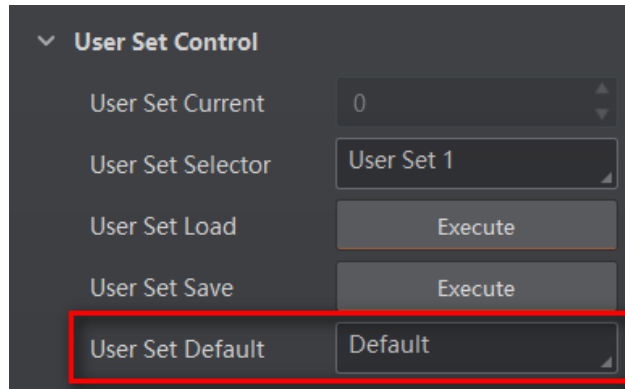

Figure 8-27 Set User Default

Chapter 9 FAQ (Frequently Asked Question)

9.1 Why the client software cannot list devices?

Reason

- The device is not powered on.
- Incorrect network cable connection.

Solution

- Check the device's power supply by observing PWR indicator.
- Check the network connection by observing ETH indicator, and make sure that the device's IP address is in the same network segment with the PC.

9.2 Why the live view is back?

Reason

- The brightness of the light source is not enough.
- Exposure time and gain value are too small.

Solution

- Increase **Lighting Duration** properly.
- Increase **Exposure Time** and **Gain** properly.

9.3 Why the image is not smooth in live view?

Reason

The network transmission speed is not up to 100 Mbps.

Solution

Check if the network transmission speed is up to 100 Mbps.

9.4 Why codes within the field of view cannot be recognized?

Reason

- Code types are not supported.
- Improper algorithm parameter settings.

Solution

- Check if code types are supported by the device or not.
- Adjust algorithm parameters properly.

Appendix A DM Code Description

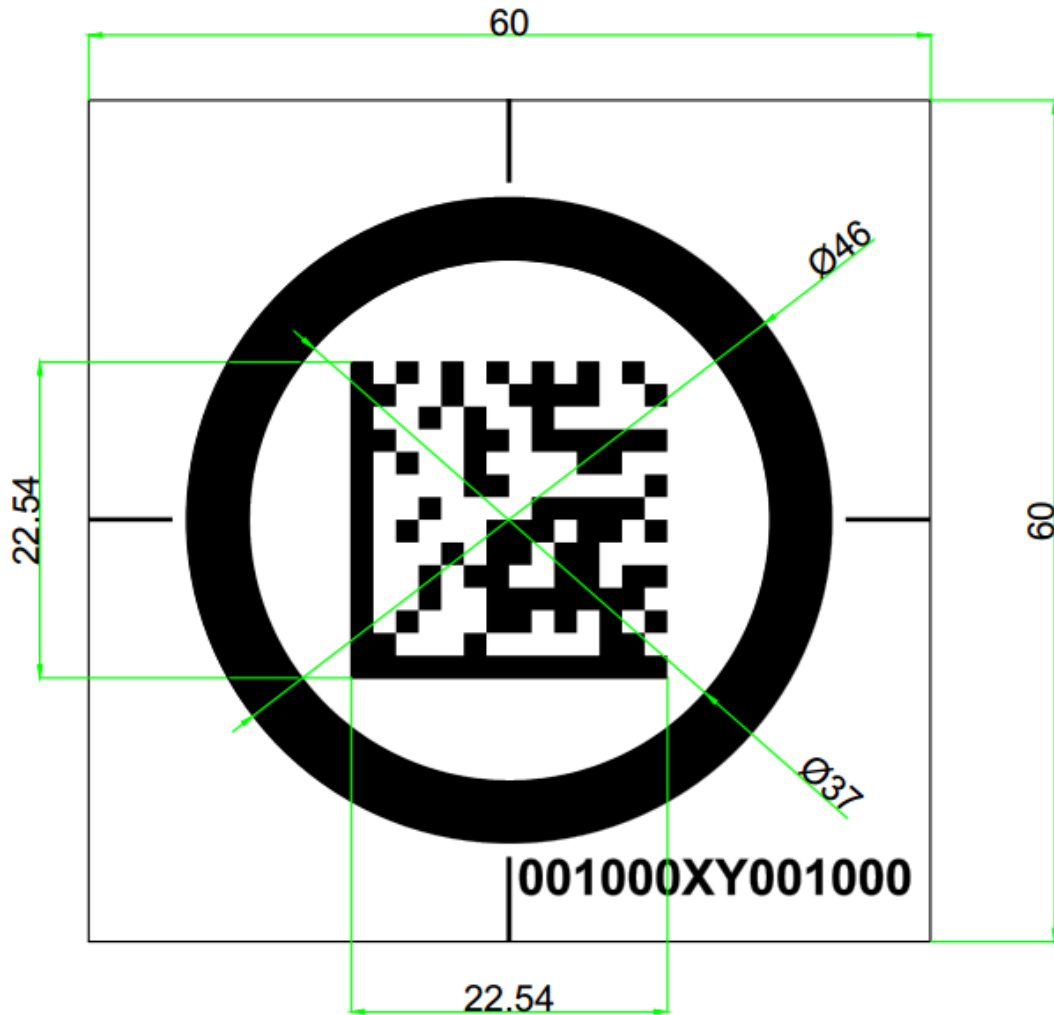

Figure A-1 DM-14 Code

Note

Contact technical support for detailed coding rule of DM code.



HIKROBOT

SHAPE OUR FUTURE INTELLIGENTLY

Hangzhou Hikrobot Technology Co.,Ltd.

E-mail: global.support@hikrobotics.com

Website: <https://en.hikrobotics.com/>

UD37853B